

# XG3000

## Digital Earth Resistance Tester

### User Manual

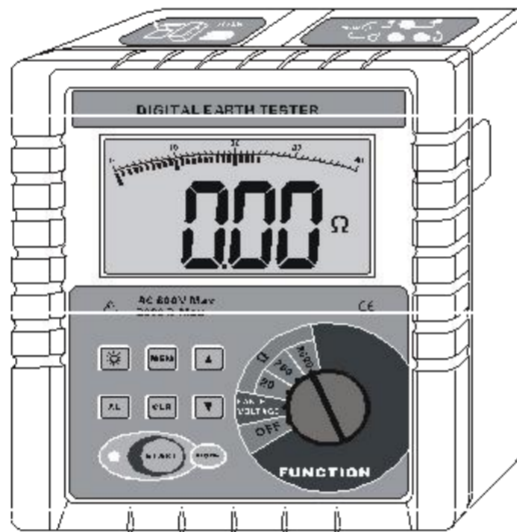

---

## CONTENT

Warning.....	2
I. Introduction.....	4
II. Measuring Range and Accuracy.....	5
III. Technical Specifications.....	5
IV. Tester Structure.....	7
V. Measuring Principle.....	8
VI. Function Quick Check.....	9
VII. Operation Methods.....	9
1. Switch On/Off.....	9
2. Battery Voltage Check.....	9
3. Insert and Connection of Rods.....	9
4. Earthing Voltage Measurement.....	10
5. Wire Resistance Verification.....	11
6. Precision Measurement.....	11
7. Simple Measurement.....	12
8. Backlight Control.....	14
9. Alarm Settings.....	14
10. Data Lock/Storage.....	14
11. Data Reading/Deletion.....	14
12. Data Upload.....	15
VIII. Battery Replacement.....	15
IX. Accessories.....	16



## Warning





**Thanks for your purchase of WX3000 Digital Earth Resistance Tester of our company. For better use of the product, please make sure:**

**---to read this user manual in details.**

**---to abide by the safety regulations and precautions strictly.**

- ◆ The tester is conforming to IEC61010 on design, production and test.
- ◆ Under any circumstance, it shall pay special attention on safety in use of this tester.
- ◆ Please don't use high-frequency signal generators like mobile phone and etc. to avoid error during measuring.
- ◆ Pay attention to words and symbols stick on the Tester.
- ◆ It shall make sure that tester and accessories are in good condition before use; it can be used only when there is no damaged, naked or broken part in testing wires or insulation layer.
- ◆ During measurement, it is forbidden to touch bare conductors and circuit under measurement.
- ◆ Before measurement, please confirm whether **FUNCTION** rotary switch has been set within the proper measuring range.
- ◆ Confirm that connector plug of lead has been inserted in the tester interface closely.
- ◆ Please don't impose over 600V A.C. or D.C. voltage on the part between testing end and interface. Otherwise, it may have damage on the tester.

- ◆ Please don't measure in an inflammable place. The flame sparkle maybe cause explosion.
- ◆ During usage of tester, please stop using it when exposed metal is caused by broken enclosure or testing wires.
- ◆ Please don't keep or store the tester in the spot with high-temperature and moisture, or condensation, and under direct daylight radiation for a long time.
- ◆ For replacing battery, please confirm testing wire has moved apart the meter, and **FUNCTION** rotary switch is in "OFF" position.
- ◆ Please put the used batteries in appointed collection place.
- ◆ The Tester has no auto shut-off function. Please set **FUNCTION** rotary switch to "OFF" after usage.
- ◆ When the meter displays battery low voltage symbol , and you need to replace the battery in time.
- ◆ If the Tester is not going to be used for a long period, remove the battery.
- ◆ Pay attention to measuring range and usage environment stipulated for the Tester.
- ◆ This measuring device is only to be used, disassembled, adjusted and repaired by qualified personnel with authorization.
- ◆ When it may cause hazard by continuous use for the reason of the Tester itself, it shall immediately stop using it and deposit it at once, leaving it for disposal by authorized agency.
- ◆ For risk of danger icon in manual "", users must perform safety operations strictly in compliance with the manual content.

## I. Introduction

**WX3000 Digital Earth Resistance Tester** is specially designed and manufactured for field measurement, adopting the latest digital and micro-processing technology, 3-pole or 2-pole method for earth resistance measurement, with a unique function of wire resistance verification, anti-interference capability and the ability to adapt to the environment, to ensure high precision, high stability and reliability for prolonged measure, which is widely used in electric power, telecommunications, meteorology, oil field, construction, lightning protection, industrial electrical equipment and other earth ground resistance measurement.

**WX3000 Digital Earth Resistance Tester** has a unique function of wire resistance verification , more accurate on measuring on-site low value earth ground resistance, which can avoid error caused by resistance change due to prolonged usage of testing wire; avoid error caused by testing wire that is failed to be fully inserted into tester interface or by poor contact; avoid error caused by users' replacing or lengthening testing wires.

**WX3000 Digital Earth Resistance Tester** is composed of host machine, monitoring software, testing wires, communication wires and others. The large LCD display of **host machine** is with blue backlight and bar graph indicating that can be seen clearly. At the same time it can store 400 sets of data, fulfilling historical inquiry and online real-time monitoring through **monitoring software**, dynamic display, with the maximum, minimum, and mean indicators, with alarm settings and alarm indicator, and with the functions like historical data access, reading, preservation, report forms, printing and so on.

## II. Measuring Range and Accuracy

Measuring Functions	Measuring Range	Accuracy	Resolution
Earth Ground Resistance	0.01Ω~20Ω	±1%rdg±3dgt (Auxiliary earth ground resistance 100Ω±5%, voltage to ground<10V)	0.01Ω
	0.1Ω~200Ω		0.1Ω
	1Ω~2000Ω		1Ω
Earth Ground Voltage	0~600V AC	±1%rdg±3dgt	1V

(Remark: 23°C±5°C, below 75%rh)

## III. Technical Specifications

<b>Function</b>	Earth ground resistance measurement, voltage to ground measurement, low value resistance measurement
<b>Power Supply</b>	DC 9V(Zi-Mn dry battery R14S 1.5V 6 PCS, continuous standby for 300 hours )
<b>Backlight</b>	Controllable blue backlight, suitable for use in dark place.
<b>Measuring Mode</b>	Precise 3-pole measurement, simple 2-pole measurement
<b>Measuring Method</b>	Earth ground resistance: rated current change-pole method, measurement current 3mA Max, 820Hz; Voltage to ground: average value rectification
<b>Data Mode</b>	Average value, maximum, minimum
<b>Wire Resistance Verification</b>	Avoid error caused by testing wire that is failed to be fully inserted into tester interface or by poor contact or by users' replacing or lengthening testing wires, making it more accurate for earth ground resistance measurement.
<b>Display Mode</b>	4-digital super-large LCD display, blue screen backlight
<b>Measuring indicator</b>	During measurement, LED flash indicator, LCD count down display
<b>LCD Dimension</b>	128mm×75mm; Display field: 124mm×67mm
<b>Dimension</b>	L×W×H: 215mm×190mm×95mm
<b>Testing Wires</b>	Three wires: each for Red 20m, Yellow 10m, and

## XG3000 Digital Earth Resistance Tester

	Green 5m
<b>Simple Testing Wire</b>	2 wires: each for Red 1.6m and Green 1.6m
<b>Auxiliary earthing rod</b>	2 PCS: $\Phi 10\text{mm} \times 150\text{mm}$
<b>Measuring Rate</b>	Voltage to ground: about 3 times/second; earth ground resistance: about 5 seconds/time
<b>Measuring Times</b>	Over 5000 times (Measuring $10\Omega$ for one time on $20\Omega$ range and take a pause for 25s)
<b>Circuit Voltage</b>	Measuring voltage to ground: measuring below AC 600V
<b>RS232 Interface</b>	Possess RS232 interface, software supervision, storage data can be uploaded to computer, saved or printed.
<b>Communication Wire</b>	One piece of RS232 communication wire, with length 1.5m
<b>Data Storage</b>	400 sets, flash display " <b>FULL</b> " icon to indicate storage is full
<b>Data Hold</b>	Data hold function: " <b>HOLD</b> " icon display
<b>Data Read</b>	Data read function: " <b>READ</b> " icon display
<b>Overflow Display</b>	Exceeding measuring range overflow function: " <b>OL</b> " icon display
<b>Alarm Function</b>	When measuring value exceeds alarm setting value, there is "Toot-toot-toot" alarm hint
<b>Battery Voltage</b>	When battery voltage decreases to about 7.8V, battery voltage low icon  will display, reminding to replace battery.
<b>Power Consumption</b>	Backlight: 25mA Max
	Standby: 25mA Max(Backlight shut off)
	Measurement: 70mA Max(Backlight shut off)
<b>Weight</b>	Tester: 1443g(including battery)
	Testing Wires: 847g(including simply testing wires)
	Auxiliary earthing rod: 468g(2 PCS)
	Meter bag: 915g
<b>Working Temperature &amp; Humidity</b>	$-10^{\circ}\text{C} \sim 40^{\circ}\text{C}$ ; below 80%rh

## XG3000 Digital Earth Resistance Tester

<b>Storage temperature &amp; humidity</b>	-20℃～60℃； below 70%rh
<b>Overload Protection</b>	Measuring earth ground resistance: between each interfaces of E-P、 E-C, AC 280V/3 seconds
<b>Insulation Resistance</b>	Over 10MΩ(between circuit and enclosure it is 500V)
<b>Withstanding Voltage</b>	AC 3700V/rms (Between circuit and enclosure)
<b>Electromagnetic Features</b>	Wireless frequency electromagnetic field
<b>Protection Type</b>	IEC61010-1 、 IEC1010-2-31 、 IEC61557-1,5 、 IEC60529(IP54)、 Pollution etc. 2、 CAT III 300V

### IV. Tester Structure

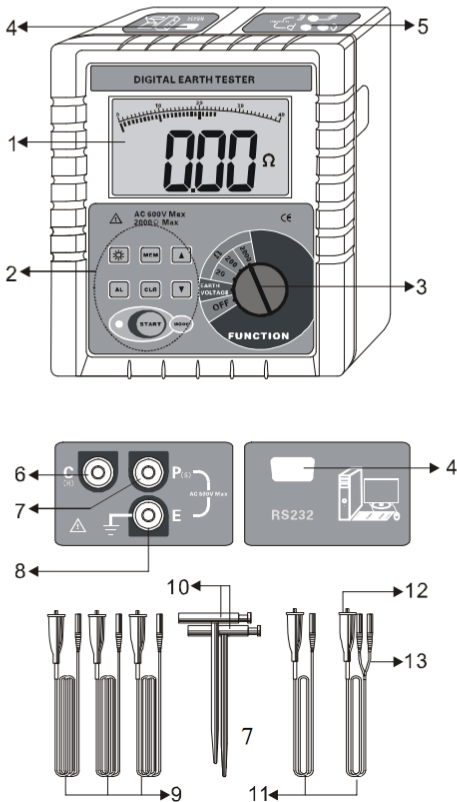

- |   |   |   |
|---|---|---|
| 1. LCD                                      | 2. Button area                              | 3. Rotary switch for selecting function |
| 4. RS232 interface                          | 5. Interface of testing wires               |   |
| 6. <b>C(H)</b> interface: Current electrode | 7. <b>P(S)</b> interface: Voltage electrode |   |
| 8. <b>E</b> interface: Earth electrode      | 9. Testing wires                            |   |
| 10. Auxiliary earthing rod                  | 11. Simple earthing wires                   |   |
| 12. Testing probe                           | 13. Safety alligator clip                   |   |

## V. Measuring Principle

1. Voltage to ground measurement adopts average value rectification method.
2. Earth resistance measurement with fall-of-potential method. AC constant current  $I$  (3mA Max, 820Hz) is applied between the measurement object **E** (earth electrode) and **C** (current electrode), and finding out the potential difference  $V$  between **E** and **P** (potential electrode).

$$R_x = V/I$$

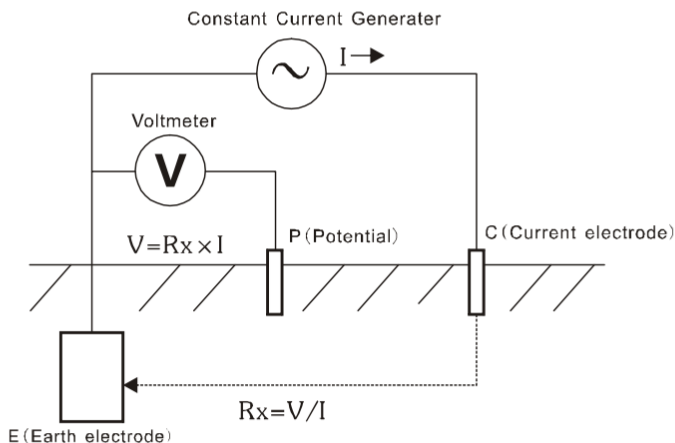

3. Maximum Operating Error: Operating error(B) is an error obtained within the rated operating conditions, and calculated with the intrinsic error(A), which is an error of the instrument used, and the error(E) due to variations.

$$B = \pm (|A| + 1.15 \times \sqrt{(E_1^2 + E_2^2 + E_3^2 + E_4^2 + E_5^2 + E_7^2 + E_8^2)})$$

**A:** Intrinsic error

- E1: Variation due to position change
- E2: Variation due to power supply voltage
- E3: Variation due to temperature change
- E4: Variation due to interference voltage change
- E5: Variation due to contact electrode resistance
- E7: Variation due to system frequency change
- E8: Variation due to system voltage change

## VI. Function Quick Check

FUNCTION rotary switch	Switch on/off ,Function shift, Switch gear
Up/down arrow button	Data read/numerical value settings
Backlight button	Backlight control
START button	Start measuring
MODE button	Maximum, Minimum or Average value mode, Move cursor
CLR button	Clear data/Delete data
MEM button	Data lock/storage/reading
AL button	Alarm function start/alarm critical value settings

## VII. Operation Methods

### 1. Switch On/Off

Rotate **FUNCTION** rotary switch to fulfill switch on and off. When rotary switch button displays "OFF" for shut-off. The Tester has no auto shut-off function, so please shut it off after usage in case of battery consumption saving.

### 2. Battery Voltage Check

After switch on, if LCD displays low battery voltage icon "", which indicates that battery voltage is low, and please replace the battery in compliance with instructions. Adequate battery power can ensure the accuracy of measurement.

### 3. Insert and Connection of Rods

Shown as the following figure, stick the auxiliary earth rods **P** and **C** into the ground deeply. They should be aligned at an interval of 5-10m from the earthed equipment under test. Connect the green wire to the earthed

equipment under test, the yellow wire to the auxiliary earth rod P and the red wire to rod C from terminals E, P and C of the instrument in order.

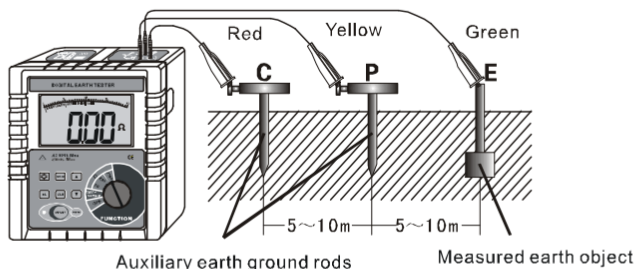

<b>Note</b>	Please try to insert auxiliary earthing rod into moist soil. In case of dry soil, sand, or gravel land, it requires adding water to keep auxiliary earthing rod inserted place wet. In case of concrete place, it shall keep auxiliary earthing rod flat and add water, and cover wet towels on earth ground rod before measurement.
-------------	--

#### 4. Earthing Voltage Measurement

	Please make sure testing wire plug has been totally inserted into testers corresponding interface and it may cause measurement value error for incomplete insert or poor contact.
	The tester cannot be used for commercial power supply voltage measurement. For special situation that needs to measure, it can only use P, E interface to connect for measurement. It is not allowed to measure commercial power voltage in the case of short circuit of P, C interface. Otherwise, measuring voltage in the earthing circuit of cutout switch may cause cutout switch start.
	On measuring earthing voltage, please do not impose <b>over 600V</b> voltage on measurement connectors.
	On measuring earthing voltage, please do not touch measured bare conductors in case of electric shock.

After connecting of auxiliary earthing rod and testing wire, shift **FUNCTION** rotary switch to “**EARTH VOLTAGE**” position. LCD display voltage value to ground. Please note the measured voltage shall NOT exceed 600V.

In general, for measuring earthing voltage, it is only to connect the testing wires corresponding to P, E interface.

<b>Note</b>	Before measuring earth ground resistance, firstly please confirm voltage to ground must be lower than 10V. Otherwise, the measurement value may cause excessive
-------------	---

error. At that time, firstly cut off power on measured earthing equipment and make resistance measurement after the earthing voltage is reduced.
--

## 5. Wire Resistance Verification

In order to improve precision and stability of field measurement of earth ground resistance, avoid error due to wire resistance change due to prolonged usage of testing wires; avoid error due to testing wire that is failed to be fully inserted into tester interface or by poor contact; avoid error due to users' replacing or lengthening testing wires and etc., wire resistance verification is specially designed, as to "20Ω" grade, which is more accurate on low value resistance measurement.

After connection of testing wire and the Tester, connect the other end of all testing wires in short circuit, as the following figure, set **FUNCTION** rotary switch to the corresponding earth ground resistance measurement position, press **▲** button to start verification. During verification, LED indicator flashes, LCD displays, and after verification, LED displays wire resistance value and stores it. For this time switch on, it will automatically deduct the verified wire resistance value from earth ground resistance measurement.

It will not preserve the verified wire resistance value on switching off. It needs re-verification for next time switching on.

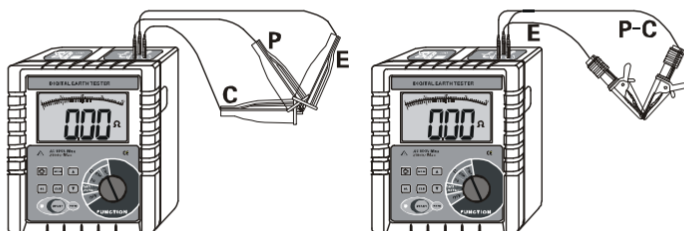

## 6. Precision Measurement



Please make sure testing wire plug has been totally inserted into testers corresponding interface and it may cause measurement value error for incomplete insert or poor contact.

As to low value earth ground resistance measurement, it will be more accurate after wire resistance verification.

On measuring earthing voltage, between E and C interface, it will occur the maximum voltage about 50V! Please do not impose voltage on measurement interface. Please pay attention to avoiding electric shock accident.

On measuring earth ground resistance, testing wires cannot be mixed around, which shall be measured separately.

	Try to choose the spot with more water to deeply bury auxiliary earthing rods P and C, in order to reduce auxiliary earth ground resistance and thus reduce indication error.
--	---

There are 3 types of display modes for earth ground resistance measurement:

**P:** --- Average Value Display

**H:** --- Maximum Display

**L:** --- Minimum Display

The default display on booting is average value, and press **MODE** button to switch display mode.

Precision measurement earth ground resistance adopts three-wire connection. After connection of auxiliary earthing rod and testing wires, set **FUNCTION** rotary switch to "2000Ω", press "START" button to start measuring. During measurement, LED indicator flashes, LCD count down displays, and after measurement, LCD displays measured values. If the display values are too small, set it to "200Ω", "20Ω" in turn, that is to choose the most appropriate gear position for measurement. The value displayed on the most appropriate position is the measured earth ground resistance value.

After measurement, press **MODE** button to check for the maximum, minimum and average value in this measurement.

After measurement, it may delete current measured values by pressing **CLR** button.

## 7. Simple Measurement



	When select commercial use power supply system earth as auxiliary earth electrode, it must use detector to confirm that is it the earth ground electrode for commercial use power supply system.
	It is forbidden to use this Tester to confirm earth electrode of commercial use power supply system

This method is a simple method for measurement that does not use auxiliary earthing rod, taking the earth electrode with the minimal existing earth ground resistance value as auxiliary earth electrode, and connecting by two simple testing wires (in which C, P interfaces are in short circuit). It can make use of metal pipes, fire hydrants and other metal buried objects, common earthing of commercial electric power system or lightning protection earth ground electrode and others to replace auxiliary earthing rods C, P, and pay attention to remove oxide layer on the connection point of the selected metal auxiliary earthing object when making measurement.

Earth ground resistance simple testing wire connection is as following figure, and refer to precision measurement for other operations.

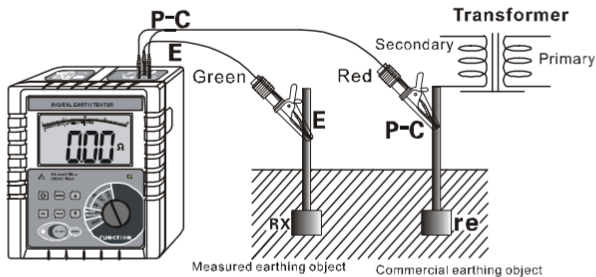

Simple method for measurement of earth ground resistance, its reading on Tester is the total value of earth ground resistance value of measured earthing object and that of commercial earthing object, namely:

$$RE = RX + re$$

In which: **RE** is the Tester reading value;

**RX** is the earth ground resistance value of measured earthing object;

**re** is the earth ground resistance value of common earthing object like commercial use power system.

Then, the earth ground resistance value of measured earthing object is:

$$RX = RE - re$$

Adopting simple method for measurement of earth ground resistance shall try to select the earthing object with low value as the auxiliary earth ground electrode and thus the tester reading value can be more approaching to true value. Please take precedence in selecting metal water pipes, fire hydrants as auxiliary earth electrode when measuring, and refer to the following figure for application.

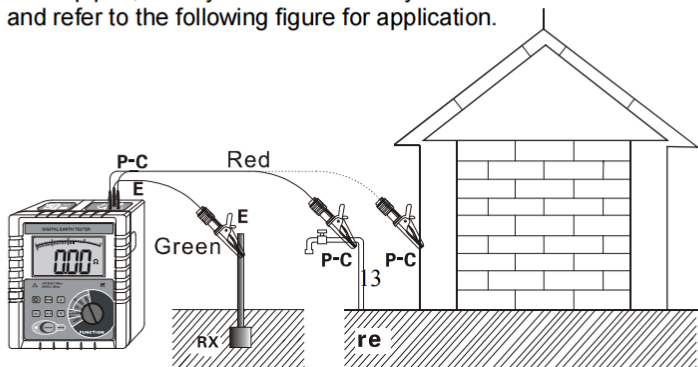







**Note**

Simple method for measurement of earth ground resistance also needs to confirm that voltage value to ground must be lower than 10V. If the voltage value is over 10V, the measurement value of earth ground resistance may cause error and at that time, it shall firstly cut off power on measured earthing equipment and make resistance measurement after the earthing voltage is decreased.





## 8. Backlight Control

After start-up, press  button to turn on or off backlight. The backlight function is suitable to dark spot. It will default backlight turn-off for each start-up.

## 9. Alarm Settings

After start-up, press  button for a brief time to open or shut off alarm function, press  button for a long time (about 3 seconds) to enter alarm critical value settings, press  or  to change current digital, press  button to move cursor and then press  button to store and exit. When measurement value is larger than alarm critical settings value and it has opened alarm function, the Tester will flash and display  icon and give out “toot-toot-toot--” alarming sound.

## 10. Data Lock/Storage

Start-up or after measurement, press  button to lock current displayed data, showing ,  icon and automatically store with serial numbers. If storage is full, the Tester will display  icon. Each group of stored data includes maximum, minimum and average value. And then press  button to remove lock.

As shown in the left figure below: the lock measurement data is 5.1Ω, as the 19th group of data storage.



## 11. Data Reading/Deletion

Start-up or after measurement, press  button for a longer time (over

3 seconds) to enter data reading, press “▲” or “▼” button to select reading data group number by step value 1, press “▲” or “▼” button constantly to select reading data group number by step value 10, press **MODE** button to read the maximum, minimum and average value of this group of data, and then press **MEM** button to exit from reading.

On reading if there is no storage data, LCD will display “- - - -”, see the above right figure.

Under data reading status, press **CLR** button to enter data deletion, press “▲” or “▼” to select “no” or “YES”, selecting “no” and then pressing **MEM** button for not deleting return data reading status, selecting “YES” and then pressing **MEM** button for deleting stored data and it will show as above right figure after deletion.

## 12. Data Upload

Make good connection of company with RS232 communication wire of the Tester, switch on the Tester and run monitoring software, and if the software displays that interface is open and the connection is successful, then it can read the stored historical data, upload to company and preserve.

**Monitoring software** has the function of online real-time monitoring and historical inquiry, dynamic display, with the maximum, minimum, and average value indication, with alarm value settings and alarm indicator, and the function of historical data access, reading, preserve, print and other functions.

## VIII. Battery Replacement

	Please don't replace battery in flammable spot
	Please don't replace battery during measurement
	Pay attention to battery polarity and specification, and don't mix use of new and used battery to avoid damage on Tester
	When the enclosure of Tester is wet, please do not open battery cover
	Please put the used batteries in appointed collection place.

1. Switch off; making sure that the Tester is under switch-off state.
2. Loosen the four screws on battery cover at the bottom of the Tester, and open battery cover.
3. Replace new battery, pay attention to battery polarity and specification, close battery cover, and fasten screw.
4. Switch on verification, otherwise re-operate.

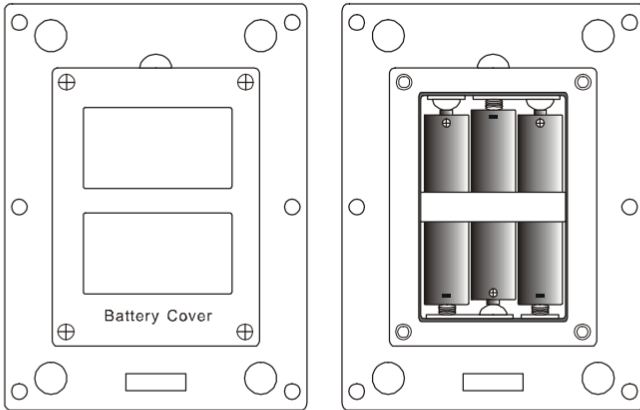

## IX. Accessories

Tester	1 PC
Tester Bag	1 PC
Auxiliary Earthing Rod	2 PCS
Monitoring Software Disk	1 Copy
RS232 Communication Cable	1 PC
Testing Wire	3 PCS
Simple testing wire	2 PCS
Zinc-manganese dry battery	6 PCS (R14S 1.5V)
Manual/Warranty card/Qualification Certificate	1 Copy